

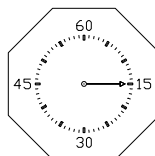

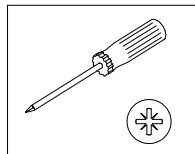

Benötigte Werkzeuge – Outils Nécessaires – Tools Required – Attrezzi Necessari

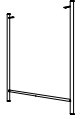
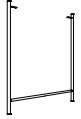

A x1  790.405	B x1  790.406	C x1  881.91310	D x1  631.31500	E x1  630.77100	F x8  631.16900
--	--	--	--	--	--

1.

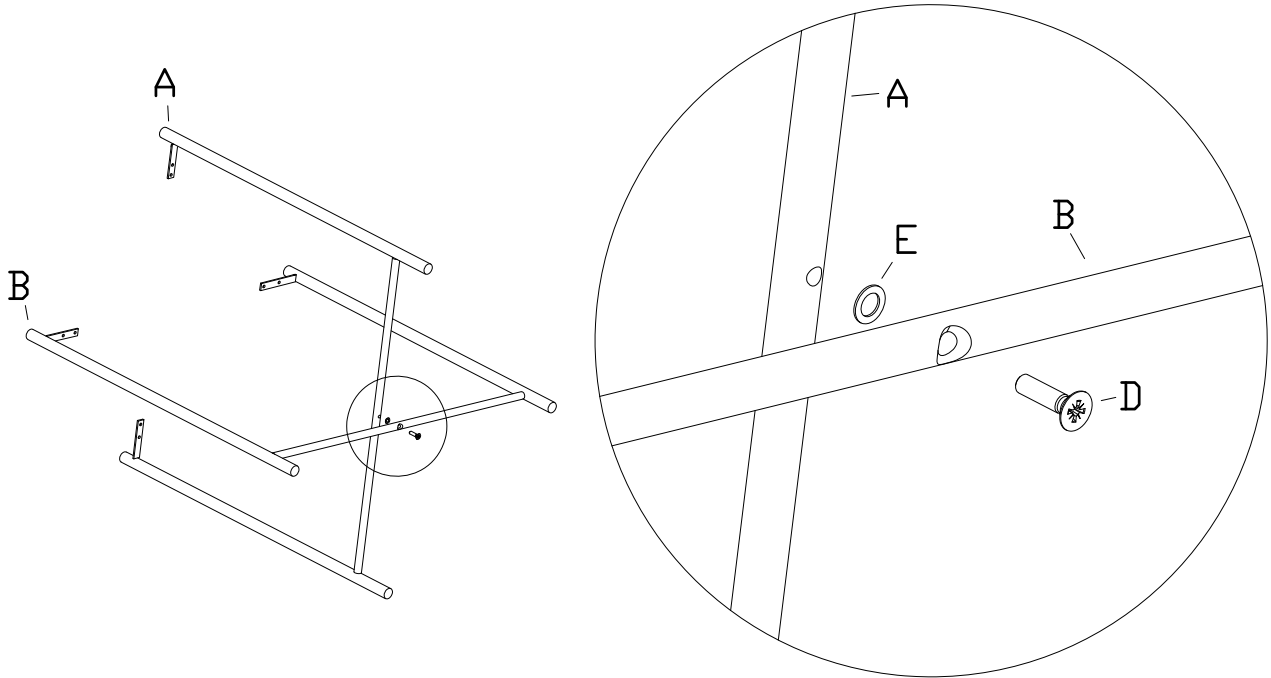

2.

